

Data Sheet



Article number: 0108093

Description: Retaining ring JK 90 DIN 984

Measures

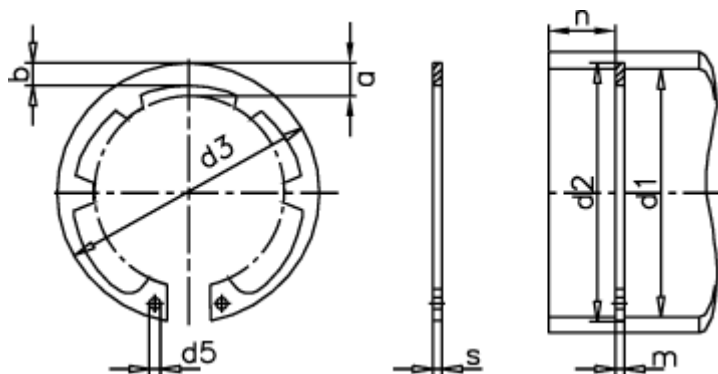

a max	= 12.2	FN kN	= 84.0	s	= 3.00
AN mm ²	= 504.0	FRg kN	= 31.4	t	= 1.75
b	= 7.7	FR kN	= 199.0	tol	= +0,35
d1	= 90	g	= 3.0	tol	= -0.08
d2	= 93.5	K kN-mm	= 364.0	tol	= +1,30-0,54
d3	= 95.5	m min	= 3.15	Tong	= ZGJ-4
d5 min	= 3.5	Nominal drive	= 5.3	Weight kg/1000	= 35.50
Description	= JK 90	Number of serrations	= 8		